

”Weatherproof“ for outdoor installation

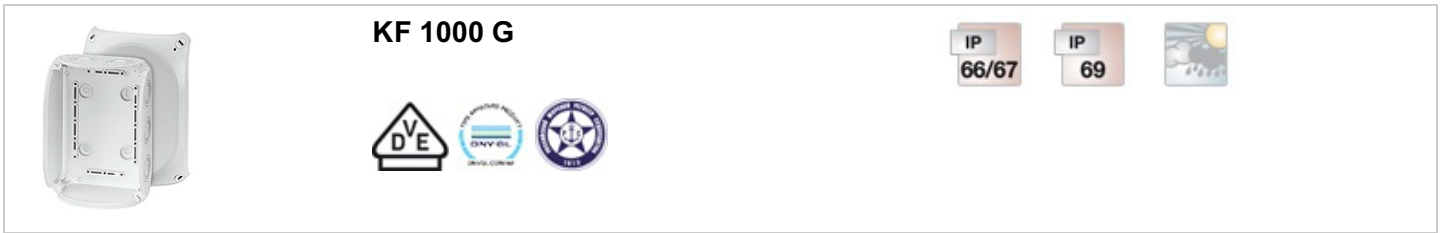

- without terminals
- with two cable entries M 25 from the rear side
- cable entries via knockouts, order AKM separately (see cable entry systems LES)
- "weatherproof" resistant to weather influences (UV due to solar radiation, protected against rainwater, temperature resistant, impact resistant, etc.)
- saltwater-proof
- "offshore applications"
- lid fasteners sealable without accessories
- retaining strap and external brackets for wall fixing included
- colour: grey, RAL 7035





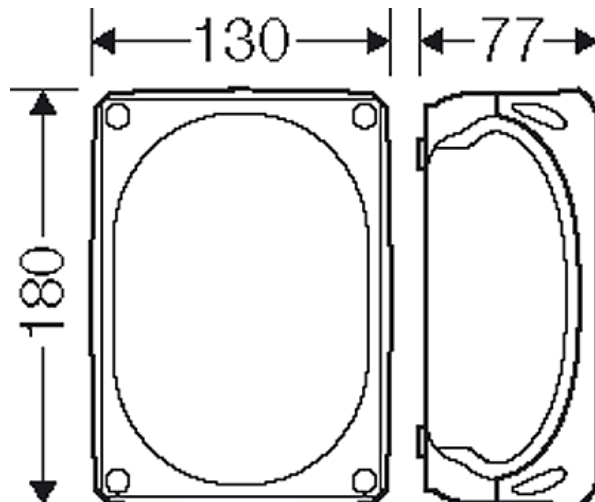

rated insulation voltage	U _i = 1000 V a.c./d.c.
material	PC-GFS (polycarbonate)
degree of protection	IP 66 / IP 67 / IP 69 IP 67, temporary submersion IP 69, water pressure max. 100 bar, water temperature max. 80 °C, distance ≥ 0.15 m
mounting width	150 mm
mounting height	97 mm
max. installation depth	62 mm
width	180 mm
height	130 mm
depth	77 mm
weight	0,268 kg
in accordance with	IEC 60670-22
in accordance with	DNV GL - Certificate No: TAE0000EE Russian Maritime Register of Shipping, technical documentation is approved by the letter No. 250-A-1180-108795

Drawings

Dimension drawing



”Weatherproof“ for outdoor installation

	<p>KF 1000 G</p>   			
---	---	---	---	---

Degree of protection against mechanical load

IK09 (10 Joule)

Toxic behaviour

halogen-free
silicone-free
"halogen-free" in accordance with the examination of the cables and insulated wires - corrosiveness of fumes - as per IEC 60754-2

Note:

For material properties see technical data.